

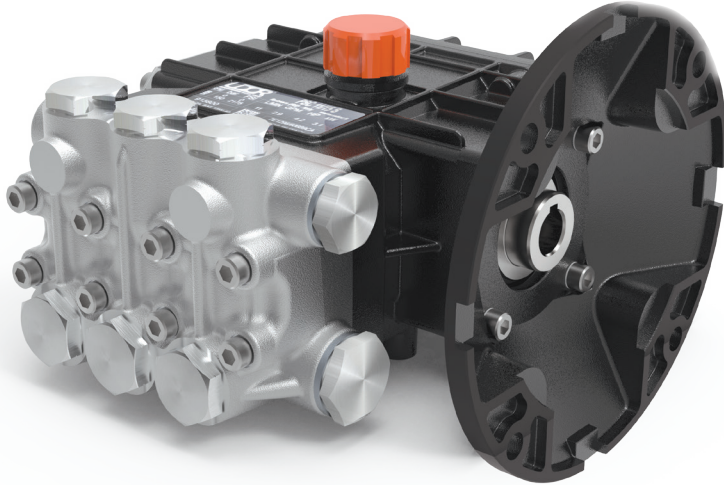

Stainless Steel PSD SERIES

Direct Drive, Electric Flange Models

5/8" Hollow Shaft with NEMA 56C Mounting Flange
1750 RPM



- 316 Stainless Steel Manifolds
- 316 Stainless Steel Valves
- 316 Stainless Steel Plunger Rods & Nuts
- 304 Stainless Steel Exterior Bolts
- Solid Ceramic Plungers
- 1/2" BSP-F Inlet. 3/8" BSP-F Outlet
- PTFE Style Packings
- 11.5 oz. Oil Capacity

PSD Series Direct Drive, Electric Flange Plunger Pumps

PSD Series stainless steel plunger pumps include a wide range of models with flow rates from 1.6 to 4.2 GPM and pressures up to 1450 PSI.

Models are also available with a 24mm solid keyed shaft

These pumps feature stainless steel wetted and exterior components to withstand the harsh environment of salt water applications.

PSD Series pumps are well suited for de-salination, disinfecting and food/pharma applications.

	Model	Flow		Pressure		Plunger Dia.	Crankshaft		Power	Seal Kit	Valve Kit	Wt.
		GPM	l/min	PSI	bar		Stroke	Code				
1750 RPM	PSD 1.6/15 Z	1.6	6.2	1450	100	18mm	5.0mm	B	1.6 EBHP	6061.B1	6061.D7	14.5 lbs
	PSD 2.4/15 Z	2.4	9.0	1450	100	18mm	7.5mm	H	2.4 EBHP	6061.B1	6061.D7	14.5 lbs
	PSD 3.0/15 Z	3.0	11.5	1450	100	18mm	9.4mm	U	3.0 EBHP	6061.B1	6061.D7	14.5 lbs
	PSD 3.6/15 Z	3.6	13.5	1450	100	18mm	10.5mm	O	3.4 EBHP	6061.B1	6061.D7	14.5 lbs
	PSD 4.2/15 Z	4.2	16.0	1450	100	18mm	12.5mm	S	4.0 EBHP	6061.B1	6061.D7	14.5 lbs



6180 140th Avenue NW
Ramsey, MN 55303

Ph: 651-785-0666
Fax: 800-732-2670

www.udorusa.com
www.boominator.com
info@udorusa.com



Scan this QR Code
for More Information

PSD-Z
2024A

MAX FLOW
MAX PRESSURE
RATED PUMP SPEED
POWER REQUIREMENT
LUBRICATION

1.6 GPM / 6.2 L/MIN
1450 PSI / 100 BAR
1750 RPM
1.6 HP ELECTRIC
10.25 OZ UDOR LUBE

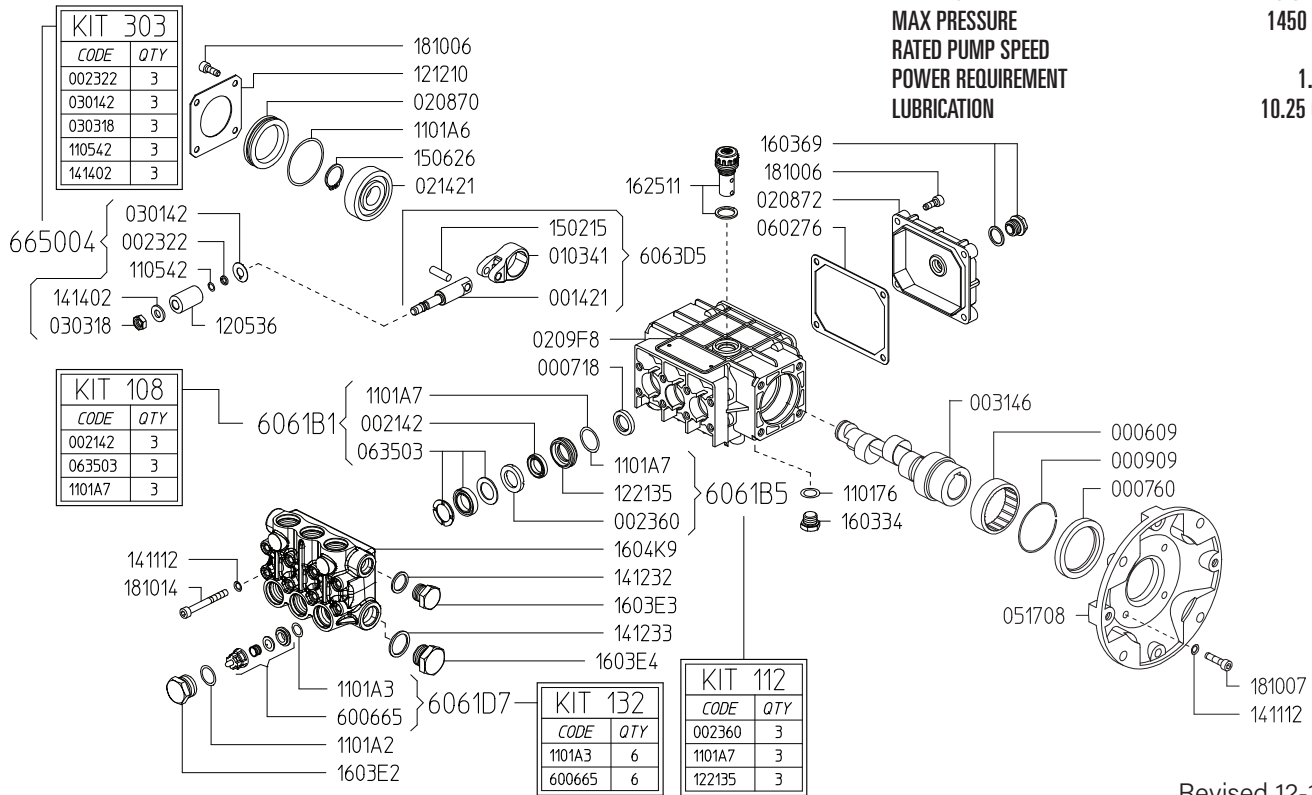

Revised 12-18-2023

Part #	Description	Qty
0006.09	BEARING - D45	1
0007.18	OIL SEAL D15	3
0007.60	OIL SEAL D25	1
0009.09	ELASTIC RING D52X2.5	1
0014.21	PLUNGER GUIDE D18 "PS"	3
0021.42	WATER SEAL L.P. D18 BPE ^B	3
0023.22	RING D6.3 ^D	3
0023.60	UPPER RING D18 "PS" SS ^C	3
0031.46	HOLLOW SHAFT "PN" D5/8" ECC=6.25	1
0103.41	CONNECTING ROD "PN/PS"	3
0208.70	COVER "PN"	1
0208.90	BACK COVER "PN/PK/PW/PS"	1
0209.56	CRANKCASE "PN/PS"	1
0214.21	BALL BEARING D20	1
0301.42	DISC "PN/PK/PKWT/PS" ^D	3
0303.18	NUT "PN/PK" SS ^D	3
0517.08	MOTOR FLANGE "PN" NEMA 56H	1
0602.76	BACK COVER GASKET "PN/PK/PW/PS"	1
0605.49	GASKET D13	1
0635.03	HIGH PRESS. SEAL KIT D15 "PN" ^B	3
1101.A2	O-RING - VALVE CAP	6
1101.A3	O-RING - VALVE ^A	6
1105.42	O-RING - PLUNGER ^D	3
1101.A6	O-RING - BEARING COVER	1
1101.A7	O-RING - LP SEAL RETAINER ^{B,C}	3
1205.36	CERAMIC PLUNGER D18 "PN/PS"	3
1212.10	METAL COVER "PN"	1

Part #	Description	Qty
1221.35	PRESSURE RING D18 "PS" SS ^C	3
1411.12	SERRATED WASHER D6 SS	4
1412.32	GASKET - DISCHARGE PLUG	1
1412.33	GASKET - INLET PLLUG	1
1414.02	WASHER D8.4 SS ^D	3
1502.15	PIN D7X25.5	3
1506.26	SNAP RING D20	1
1603.68	PLUG G1/4	1
1603.69	OIL PLUG G1/4 + GASKET	1
1603.E2	VALVE PLUG "PS/MS" SS	6
1603.E3	PLUG G3/8 SS	1
1603.E4	PLUG G1/2 SS	1
1604.K9	HEAD "PS" PISTON D18 SS	1
1625.10	OIL PLUG G3/8 "PN"	1
1810.06	ALLEN SCREW M6X16 SS	4
1810.07	ALLEN SCREW M6X25 SS	4
1810.14	ALLEN SCREW M6X60 SS	8
1810.15	ALLEN SCREW M6X35 SS	4
6006.65	VALVE ASSY "PS/MS" W/O O-RING ^A	6
6061.B1	WATER SEAL KIT D18 "PS" (KIT 108)	
6061.B5	SS RING KIT D18 "PS" (KIT 112)	
6061.D7	VALVE KIT "PS/MS" 110 (KIT 132)	
6650.04	PLUNGER KIT D18 "PS" (KIT 303)	

^A Parts in 6061.D7 (Kit 132).
^B Parts in 6061.B1 (Kit 108).
^C Parts in 6061.B5 (Kit 112).
^D Parts in 6650.04 (Kit 303).

*Dimensional Drawings are
Shown in Millimeters.
To Convert to Inches,
Multiply Dimension x 0.03937*

PS SERIES PUMPS - 5/8" HOLLOW SHAFT w/ NEMA 56C FLANGE

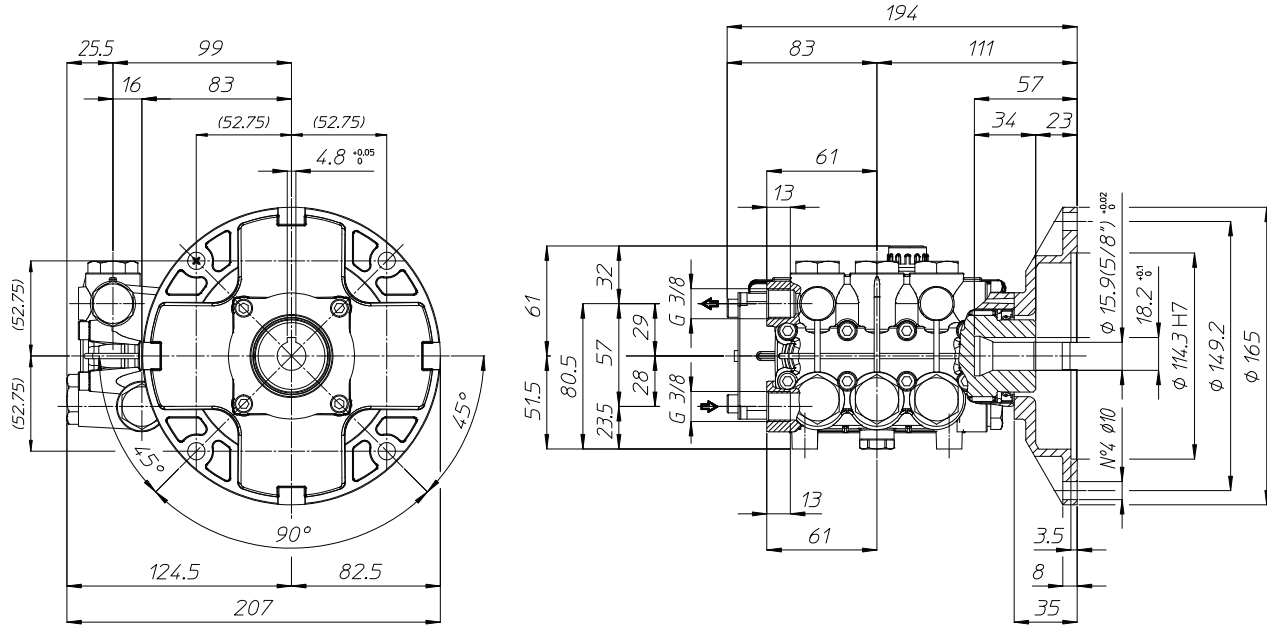

TORQUE SPECS

Ref.	Description	Ft./lb.	Nm	Loctite®
1	Head Bolts	8	11	-
2	Valve Caps	75	100	243
3	Inlet Cap	60	80	-
4	Outlet Cap	60	80	243
5	Bearing Flange Bolts	8	11	-
6	Rear Cover Bolts	8	11	-
7	Connecting Rod Bolts	-	-	-
8	Plunger Bolts	11	15	270
9	Valve Cover Bolts	-	-	-
10	Oil Drain Plug	6	8	-

