

- Brass Manifold
- Heat Treated Crankshaft
- Stainless Steel Piston Guides
- High Strength Aluminum Alloy or Bronze Connecting Rods
- Industrial Quality Ball Bearings and Needle Bearings
- Solid Ceramic Plungers
- Stainless Steel Check Valves
- Heavy Duty Flat Base High Pressure Seals
- Dual Oil Sight Gauges
- 10.25 oz. Capacity Vented Oil Bath Crank Case
- 3/8" BSP-F Inlet. 3/8" BSP-F Outlet
- Max Fluid Temp, 160°F

### PNC Series 24mm Keyed Solid Shaft Plunger Pumps

PNC Series standard duty plunger pumps include a wide range of models with flow rates from 0.5 to 3.4 GPM and pressures up to 2465 PSI.

Other drive options include gas engine flange, electric motor flange, gas engine gear reduction and hydraulic motor flange.

Applications include general pressure cleaning, sewer jetting, vehicle wash equipment and fire fighting applications.

	Model	Flow		Pressure		Plunger Dia.	Crankshaft		Power	Seal Kit	Valve Kit	Wt.
		GPM	l/min	PSI	bar		Stroke	Code				
1450 RPM	PNC 02/10 S	0.5	2.0	1450	100	15mm	3.0mm	K	0.5 EBHP	6061.07	6061.01	12 lbs
	PNC 04/10 S	1.1	4.0	1450	100	15mm	5.5mm	D	1.0 EBHP	6061.07	6061.01	12 lbs
	PNC 06/10 S	1.6	6.0	1450	100	15mm	8.0mm	4	1.5 EBHP	6061.07	6061.01	12 lbs
	PNC 09/11 S	2.4	9.0	1595	110	15mm	12.5mm	S	2.5 EBHP	6061.07	6061.01	12 lbs
	PNC 11/17 S	2.9	11	2465	170	18mm	10.5mm	O	5 EBHP	6061.08	6061.01	12 lbs
	PNC 13/15 S	3.4	13	2175	150	18mm	12.5mm	S	5 EBHP	6061.08	6061.01	12 lbs

NOTE: All pump models available with left-hand drive option. Add 'L' to model number when ordering (ex. PNC 11/17 SL)



MAX FLOW  
MAX PRESSURE  
RATED PUMP SPEED  
POWER REQUIREMENT  
LUBRICATION

0.5 GPM / 2.0 L/MIN  
1450 PSI / 100 BAR  
1450 RPM  
0.5 HP ELECTRIC  
10.25 OZ UDOR LUBE

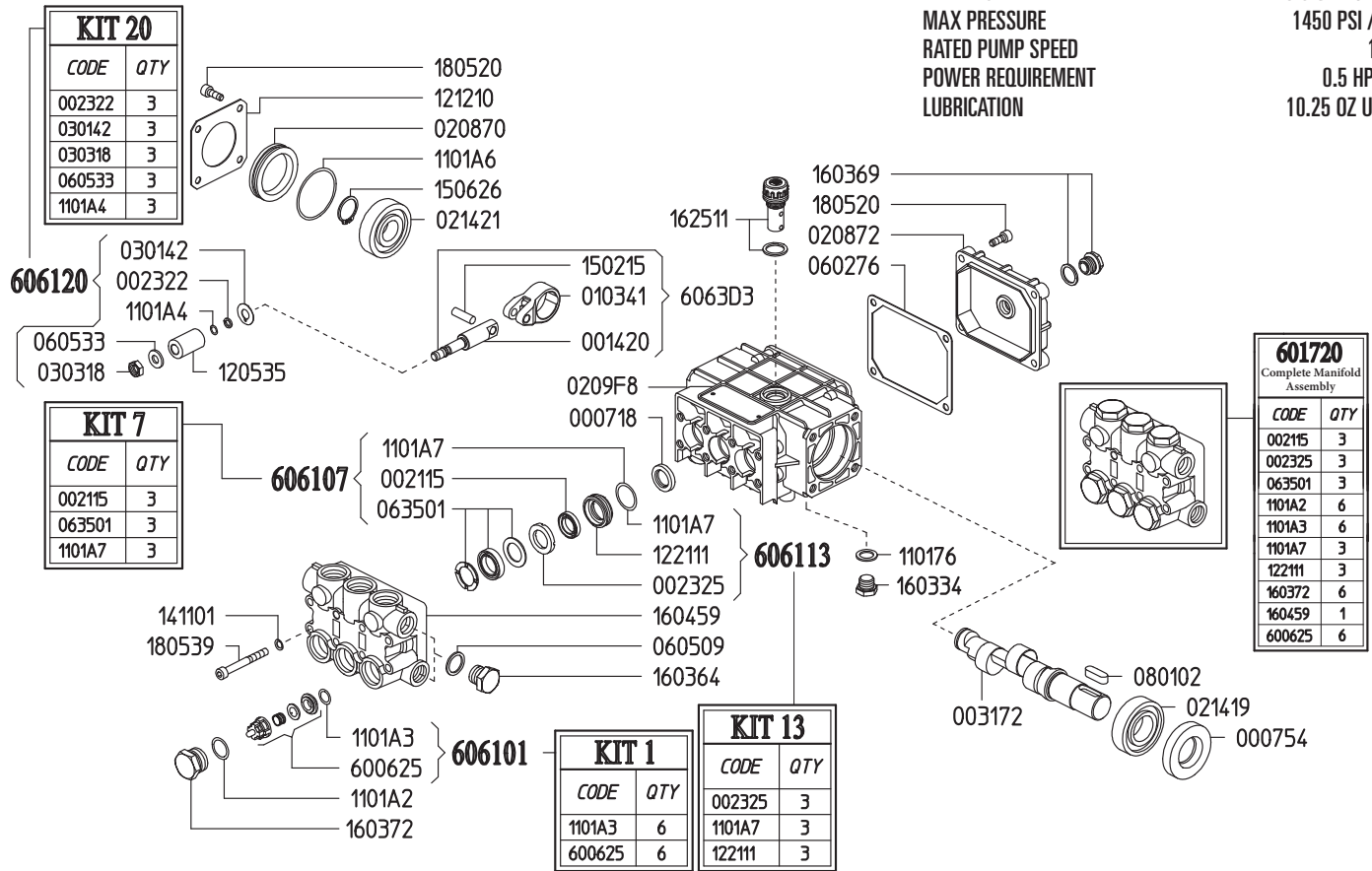

Revised 10-19-2023

Part #	Description	Qty	Part #	Description	Qty
0007.18	OIL SEAL D15X24X5	3	1101.A7	O-RING - LP SEAL RETAINER <sup>BCE</sup>	3
0007.54	OIL SEAL D25X52X10	1	1205.35	CERAMIC PLUNGER D15X30 "PN"	3
0014.20	PLUNGER GUIDE D15/18 "PN"	3	1212.10	METAL COVER "PN"	1
0021.15	WATER SEAL LP. D15 <sup>BE</sup>	3	1221.11	LOW PRESS. SEAL RETAINER D15 <sup>CE</sup>	3
0023.22	RING D6.3X9X1.3 2021 "PN/C/G" <sup>CE</sup>	3	1411.01	SERATED WASHER D6	12
0023.25	INTERMEDIATE RING D15 "PN"	3	1502.15	PIN D7X25.5	3
0031.72	MALE SHAFT "PN" D24	1	1506.26	SNAP RING D20	1
0103.41	CONNECTING ROD "PN/PS"	3	1603.34	PLUG G1/4	1
0208.70	COVER "PN"	1	1603.64	PLUG G3/8	1
0208.72	BACK COVER "PN"	1	1603.69	OIL PLUG G1/4+GASKET	1
0209.F8	CRANKCASE	1	1603.72	VALVE PLUG "PN" PISTON D15/18 <sup>AE</sup>	6
0214.19	BALL BEARING D25X52X15 6205 QL	1	1604.59	HEAD "PN" PISTON D15/18	1
0214.21	BALL BEARING D20X52X15	1	1625.11	OIL PLUG G3/8 "PN"	1
0301.42	SLINGER RING <sup>D</sup>	3	1805.20	ALLEN BOLT M6X16	8
0303.18	NUT M8XH5 <sup>D</sup>	3	1805.39	ALLEN BOLT M6X60	8
0602.76	BACK COVER GASKET	1	6006.25	VALVE ASSEMBLY W/O O-RING <sup>AE</sup>	6
0605.09	GASKET D17X23X1.5 (G3/8)	1	6017.20	COMPLETE MANIFOLD ASSEMBLY	1
0605.33	GASKET D8X14X2 <sup>D</sup>	3	6061.01	KIT 1 - VALVE KIT "PN/PW"	1
0635.01	HIGH PRESS. SEAL ASSY D15 <sup>BE</sup>	3	6061.07	KIT 7 - WATER SEAL KIT D15 "PN/PK"	1
0801.02	KEY A8X7X25	1	6061.13	KIT 13 - BRASS RING KIT D15 "PN"	1
1101.76	O-RING - OIL PLUG	1	6061.20	Kit 20 - PLUNGER KIT D15/18 "PN"	1
1101.A2	O-RING - VALVE CAP <sup>E</sup>	6			
1101.A3	O-RING - VALVE <sup>AE</sup>	6			
1101.A4	O-RING - PLUNGER <sup>D</sup>	3			
1101.A6	O-RING - BEARING COVER	1			

<sup>A</sup> Parts in 6061.01 (Kit 1).

<sup>B</sup> Parts in 6061.07 (Kit 7).

<sup>C</sup> Parts in 6061.13 (Kit 13).

<sup>D</sup> Parts in 6061.20 (Kit 20).

<sup>E</sup> Parts in 6017.20 (Complete Manifold Assembly).

*Dimensional Drawings are  
Shown in Millimeters.  
To Convert to Inches,  
Multiply Dimension x 0.03937*

## PN SERIES PUMPS - 24MM SOLID SHAFT

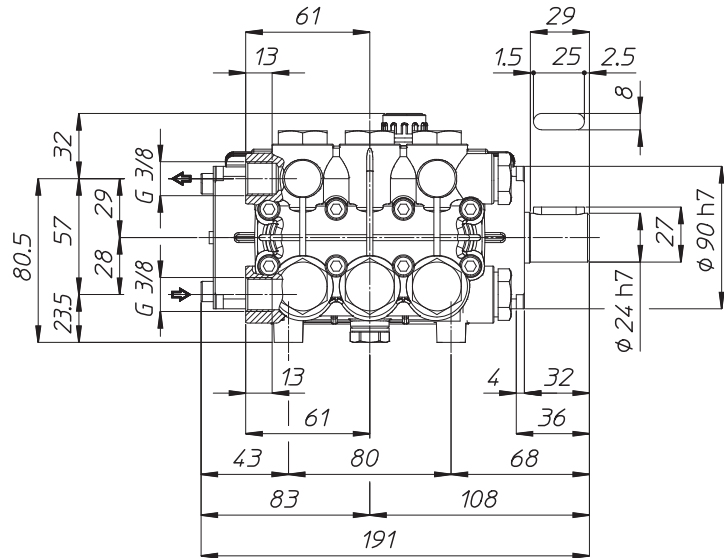
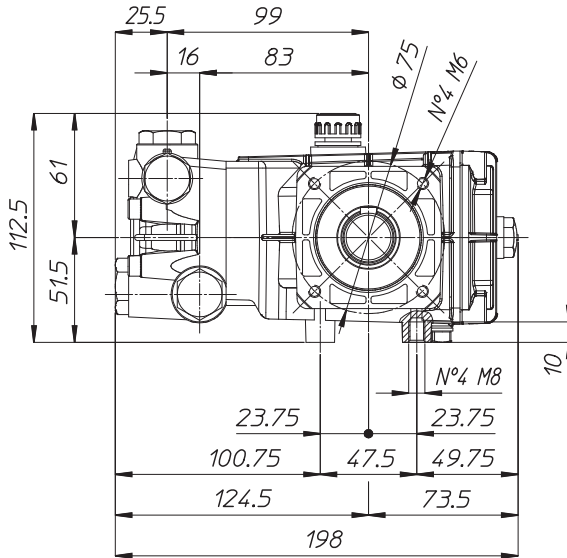

## TORQUE SPECS

Ref.	Description	Ft./lb.	Nm	Loctite®
1	Head Bolts	8	11	-
2	Valve Caps	75	100	243
3	Inlet Cap	60	80	-
4	Outlet Cap	60	80	243
5	Bearing Flange Bolts	8	11	-
6	Rear Cover Bolts	8	11	-
7	Connecting Rod Bolts	-	-	-
8	Plunger Bolts	11	15	270
9	Valve Cover Bolts	-	-	-
10	Oil Drain Plug	6	8	-

